



Trend Micro™ TippingPoint™

Threat Protection System (TPS)

Hardware Specification and

Installation Guide

Trend Micro Incorporated reserves the right to make changes to this document and to the product described herein without notice. Before installing and using the product, review the readme files, release notes, and/or the latest version of the applicable documentation, which are available from the Trend Micro website at:

<https://docs.trendmicro.com/en-us/tippingpoint/threat-protection-system.aspx>

Trend Micro, the Trend Micro t-ball logo, TippingPoint, and Digital Vaccine are trademarks or registered trademarks of Trend Micro Incorporated. All other product or company names may be trademarks or registered trademarks of their owners.

Copyright © 2024. Trend Micro Incorporated. All rights reserved.

Document Part No.: TPÉM09846/230927

Release Date: April 2024

Protected by U.S. Patent No.: Pending

This documentation introduces the main features of the product and/or provides installation instructions for a production environment. Read through the documentation before installing or using the product.

Detailed information about how to use specific features within the product may be available at the Trend Micro Online Help Center and/or the Trend Micro Knowledge Base.

Trend Micro always seeks to improve its documentation. If you have questions, comments, or suggestions about this or any Trend Micro document, please contact us at docs@trendmicro.com.

Evaluate this documentation on the following site:

<https://www.trendmicro.com/download/documentation/rating.asp>

Privacy and Personal Data Collection Disclosure

Certain features available in Trend Micro products collect and send feedback regarding product usage and detection information to Trend Micro. Some of this data is considered personal in certain jurisdictions and under certain regulations. If you do not want Trend Micro to collect personal data, you must ensure that you disable the related features.

The following link outlines the types of data that TippingPoint Threat Protection System collects and provides detailed instructions on how to disable the specific features that feedback the information.

<https://success.trendmicro.com/data-collection-disclosure>

Data collected by Trend Micro is subject to the conditions stated in the Trend Micro Privacy Notice:

<https://www.trendmicro.com/privacy>

Table of Contents

Chapter 1: TPS Hardware Specification and Installation

TPS TXE Series devices	1-3
TPS TX Series devices	1-3
TPS 2200T device	1-6
TPS 440T device	1-7

Chapter 2: TPS TXE devices overview

Chassis – front panel	2-2
Chassis – rear panel	2-2
Chassis – features	2-2
Fans and power supplies	2-3
External SSD	2-3
Ports	2-3
Chassis LEDs	2-5
Model requirements	2-6
Power requirements	2-6
Cabling requirements	2-7
I/O modules	2-7
Technical specifications	2-12

Chapter 3: TPS 1100TX and 5500TX devices overview

Chassis – front panel	3-2
Chassis – rear panel	3-3
Chassis – features	3-3
Fans and power supplies	3-4
External SSD	3-4
Ports	3-4

Chassis LEDs	3-5
Model requirements	3-6
Power requirements	3-6
Cabling requirements	3-7
I/O modules	3-7
Technical specifications	3-7

Chapter 4: TPS 8200TX and 8400TX devices overview

Chassis – front panel	4-2
Chassis – rear panel	4-3
Chassis – features	4-3
Fans and power supplies	4-4
External SSD	4-4
Ports	4-4
Chassis LEDs	4-5
Model requirements	4-6
Power requirements	4-7
Cabling requirements	4-7
I/O module installation	4-7
Before you begin	4-8
ESD requirements	4-8
I/O module options	4-8
Module LEDs	4-13
I/O module replacement	4-14
Supported transceivers and cables for TippingPoint I/O modules	4-15
Technical specifications	4-15

Chapter 5: TPS 2200T device overview

Chassis – front panel	5-2
Chassis – rear panel	5-3

Chassis – features	5-3
System status indicator	5-4
Alert indicator	5-4
Fans and power supplies	5-4
External storage card	5-4
Ports	5-5
Model requirements	5-5
Power requirements	5-6
Cabling requirements	5-6
Pluggable transceivers	5-6
Technical specifications	5-7

Chapter 6: TPS 440T product overview

Chassis – front panel	6-2
Chassis – rear panel	6-3
Chassis – features	6-3
System status indicator	6-3
Alert indicator	6-4
Fans and power supplies	6-4
External storage card	6-4
Ports	6-5
Model requirements	6-5
Power requirements	6-6
Cabling requirements	6-6
Technical specifications	6-6

Chapter 7: Install your TPS device

Install the chassis	7-3
Determine total rack space	7-3
Attach the device to the rack	7-3
Connect the power supply	7-4
Install the external storage card	7-5

Add the I/O modules – TPS TX Series	7-5
Add the I/O modules – TPS TXE devices	7-7
Attach the cables	7-9
Connect the console port	7-9
Connect the management port	7-9
Turn on the device	7-10
Run the setup wizard	7-10
Install your license package	7-11
Attach network connections	7-12
Where to go next	7-12

Chapter 8: Power supplies

AC power supply – TPS 2200T, TX, and TXE devices	8-2
Connect the AC power supply	8-4
DC power supply – TPS TX and TXE devices	8-5
Connect the DC power supply	8-5

Chapter 9: Fans

Replace the fan – 8200TX, 8400TX, and TXE devices only	9-3
--	-----

Chapter 10: Power cord retention bracket

Install the retention bracket	10-3
Attach the power cord retention bracket	10-3
Remove the bracket	10-4

Chapter 11: External user disk

External SSD	11-2
External CFast storage card	11-3
External user disk commands	11-4

Chapter 1

Overview

The Trend Micro™ TippingPoint™ Threat Protection System (TPS) is a high-performance, enterprise-class solution that protects your network by scanning, detecting, and responding to network traffic according to the filters, action sets, and global settings maintained on each device by a client.

The TPS offers improved technology that is optimized for higher throughput, high resiliency, high availability, and network segment protection from both external and internal attacks. In addition, the TXE model offers improved hardware acceleration that enables characterizing and network visibility capabilities.

You can install as many TPS security devices as you need to strategically protect your network enterprise zones. You can manage a device by using its command line interface (CLI) or by using the Security Management System (SMS) console.

Learn more about each TPS product in the following sections:

- [TPS TXE Series devices on page 1-3](#)
- [TPS TX Series devices on page 1-3](#)
- [TPS 2200T device on page 1-6](#)
- [TPS 440T device on page 1-7](#)

For information about the Virtual Threat Protection System (vTPS) virtual appliance, refer to that product documentation.

TPS TXE Series devices



TPS TXE security devices include the 9200TXE device and the 8600TXE device, which provide the following hardware features.

FEATURE	DESCRIPTION
Ports	1GbE Copper + 25GbE SFP28 management ports Dual QSFP28-DD (400Gbps Full-Duplex Total) special purpose ports RJ-45 serial console port
Slots	Two I/O slots
AC Power supply	9200TXE: Two hot-swappable, replaceable (1500W/110V and 2000W/220V) PSUs 8600TXE: Two hot-swappable, replaceable (1200W/110V) PSUs 1+1 redundant
External storage	One 240 GB SSD
Fans	Seven hot-swappable dual-rotor 40 mm modules

TPS TX Series devices

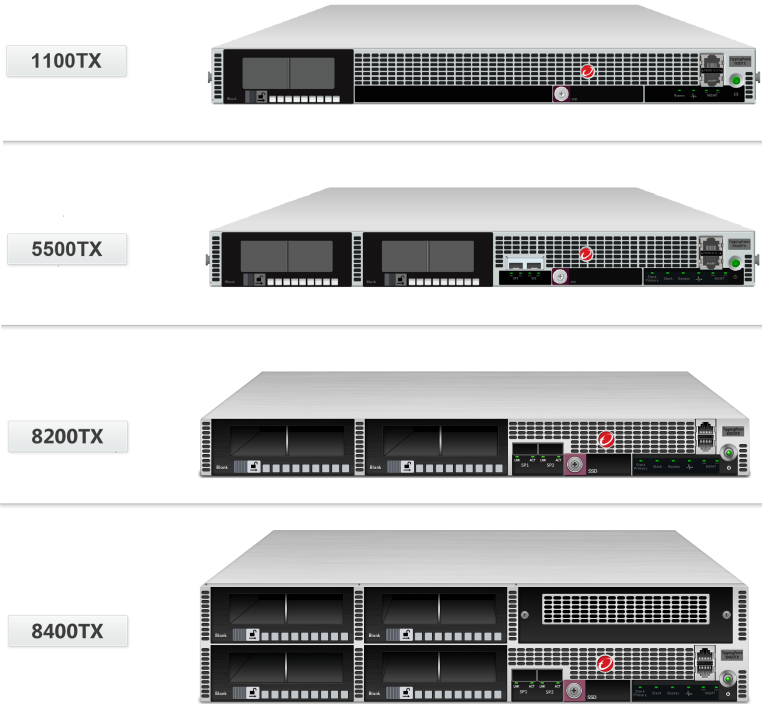

The TPS TX Series security devices provide the following hardware features.

FEATURE	MODEL	DESCRIPTION
Ports	1100TX	<ul style="list-style-type: none"> • One RJ-45 console port • One 1 GbE copper management port

FEATURE	MODEL	DESCRIPTION
	5500TX	<ul style="list-style-type: none"> • Two fixed SFP+ special purpose (SP) ports (not used in this TOS release) • One RJ-45 console port • One 1 GbE copper management port
	8200TX and 8400TX	<ul style="list-style-type: none"> • Two fixed QSFP+ special purpose (SP) • One RJ-45 console port • One 1 GbE copper management port
Slots	1100TX	One I/O slot
	5500TX	Two I/O slots
	8200TX	Two I/O slots
	8400TX	Four I/O slots
Power supply	1100TX	One replaceable 250W AC power supply
	5500TX	Two hot-swappable, redundant 250W AC power supplies
	8200TX and 8400TX	Two hot-swappable, redundant 750W AC power supplies
External storage	1100TX	One 8 GB SSD
	5500TX, 8200TX, and 8400TX	One 32 GB SSD
Fans	1100TX	Two (nonreplaceable)
	5500TX	Three (nonreplaceable)
	8200TX and 8400TX	Seven (replaceable and hot-swappable)

TPS 2200T device

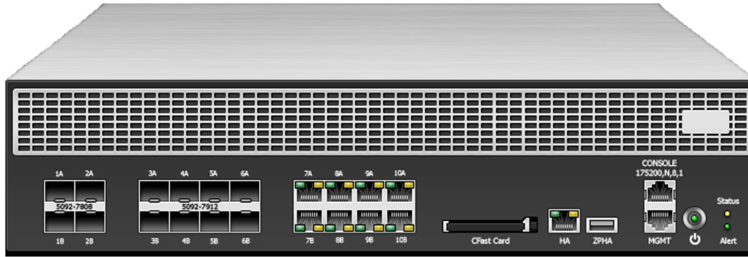

The TPS 2200T device provides the following hardware features.

FEATURE	2200T DEVICE
Ports	One RJ-45 console port One 1 GbE copper management port
1 GbE copper ports	8
1 GbE SFP ports	8
10 GbE* SFP+ ports	4
Power supply	2 hot-swappable 750W AC power supplies
External storage	One 8 GB CFast
System fans	3 fans (not replaceable)
Dedicated High Availability (HA) port	Yes
Zero Power High Availability (ZPHA)**	Built-in ZPHA for copper segments External ZPHA port for SFP and SFP+ segments

*Rate does not include autonegotiation. Dual-rate SFP+ transceivers are not supported.

**To learn more about installing and operating a ZPHA module, refer to *TippingPoint ZPHA Installation Guide – Modular and Non-Modular*.

TPS 440T device



The TPS 440T device provides the following hardware features.

FEATURE	440T DEVICE
Ports	One RJ-45 console port One 1 GbE copper management port
1 GbE copper ports	8
Power supply	One 350W (built-in) power supply
External storage	One 8 GB CFast
System fans	3 internal fans (not replaceable)
Dedicated High Availability (HA) port	Yes
Zero Power High Availability (ZPHA)	Built-in ZPHA for copper segments

Chapter 2

TPS TXE devices overview

The following topics describe the components, chassis, requirements, and installation specifics of the 9200TXE and 8600TXE devices, which are physically very similar and have many of the same components:

- *Chassis – front panel on page 2-2*
- *Chassis – rear panel on page 2-2*
- *Chassis – features on page 2-2*
- *Model requirements on page 2-6*
- *I/O modules on page 2-7*
- *Technical specifications on page 2-12*

Learn more on page 7-1 about installing the device. Prior to installation, have the *TPS CLI Reference* available for configuration information.

Chassis – front panel

The following illustration shows the front panel view of TXE devices (9200TXE is shown):

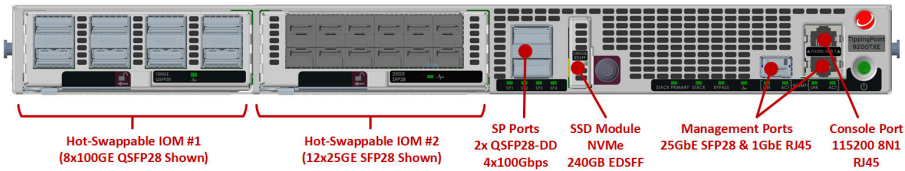

FIGURE 2-1. TXE front panel

Chassis – rear panel

The following illustration shows the rear panel view of TXE devices (9200TXE is shown):

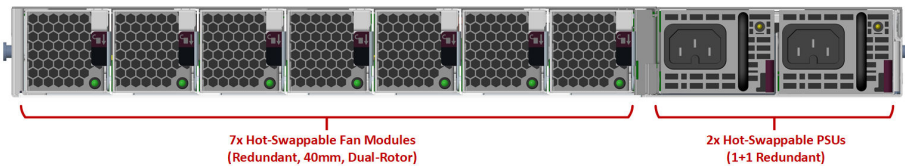

FIGURE 2-2. TXE rear panel

Chassis – features

Refer to the following topics for information about the chassis features of TXE devices:

- [Fans and power supplies on page 2-3](#)
- [External SSD on page 2-3](#)
- [Ports on page 2-3](#)
- [Chassis LEDs on page 2-5](#)

Fans and power supplies

TXE devices includes:

- Two hot-swappable power supplies
- Seven hot-swappable fans

Learn more about [Power supplies on page 8-1](#) and [Fans on page 9-1](#).

External SSD

The TXE device includes an external SSD module that ships pre-installed with your product. The SSD is used to store traffic logs, snapshots, and other system data. You can remove and install the card while the device is running; however, to do so, you must issue the appropriate unmounting, mounting, and preparation commands from the device CLI.

[Learn more on page 11-4](#) about these external user disk commands.

Ports

The TXE device comes equipped with network slots for standard or bypass I/O modules.

The device provides a console and 1-GbE management port:

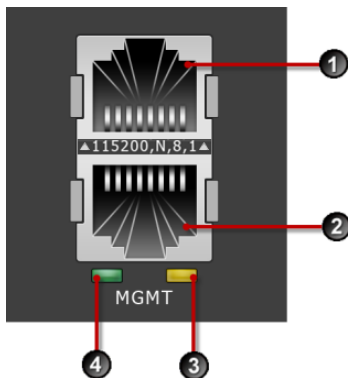

FIGURE 2-3. Console and management ports

1. 1 RJ-45 serial console port
2. 1 GbE copper management port
3. Activity LED
4. Link LED

The device also provides a 25-GbE-capable SFP28 management port:

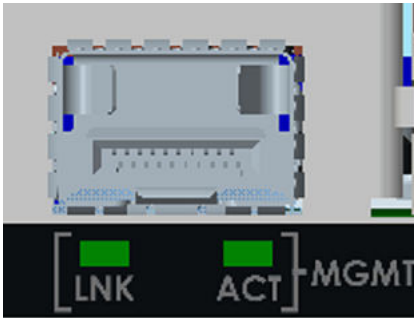

FIGURE 2-4. SFP28 management port



Note

The SFP28 management port does not support a 1 GbE Copper SFP. It will support the following interfaces:

- 1 GbE Fiber SFP
 - 10 GbE Fiber SFP+
 - 25 GbE Fiber SFP28
-

In addition, two special purpose ports can be used for stacking:

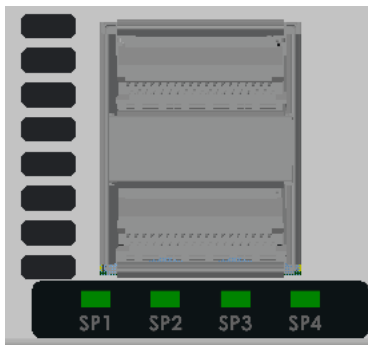

FIGURE 2-5. Special purpose ports

Chassis LEDs

When you turn on the device, the system completes a series of component checks and then displays LED indicators to show the status of each component:

- Stack Primary status
 - Solid green: The device is the stack primary.
 - Off: The device is not the stack primary.
- Stack status
 - Amber: The device is not ready to inspect network traffic.
 - Flashing green: The device is RTI but is not currently inspecting network traffic.
 - Solid green: The device is RTI and is inspecting network traffic.
 - Off: Stacking is not enabled on the device.
- Bypass status
 - Solid red: The device is in Intrinsic High Availability (Intrinsic HA) Layer-2 Fallback (L2FB) mode.

- Off: The device is not in L2FB mode.



System health status

- Flashing green: The system is booting up and is not yet ready to inspect traffic.
- Solid green: The system is healthy.
- Red: The system is experiencing a health alert, such as a fan failure. This state resets to solid green when you view the system log.
- Management port status
 - Link LED: Solid green indicates that the port is linked and ready for data.
 - Activity LED: Flashing amber indicates that the port is passing data.

Model requirements

Refer to the following topics for specific requirements of TXE devices.

- [Power requirements on page 2-6](#)
- [Cabling requirements on page 2-7](#)

Power requirements

The 9200TXE device requires Alternating Current (AC) that meet the following requirements:

- Voltage: 100 V to 240 V
- Current: 15 A to 10 A
- Frequency: 47 Hz to 63 Hz (Tolerance: 50 Hz to 60 Hz)

The 8600TXE device requires Alternating Current (AC) that meet the following requirements:

- Voltage: 100 V to 240 V
- Current: 12 A (maximum)
- Frequency: 47 Hz to 63 Hz (Tolerance: 50 Hz to 60 Hz)

All TXE devices ship with two AC power supplies.

Consult your TippingPoint account contact for more information if you require a DC power supply. The TXE device requires Direct Current (DC) that meets the following requirements:

- Voltage: -40 V to -60 V
- Current: 50 A (maximum) for the 9200TXE device; 30 A (maximum) for the 8600TXE device
- An all-pole mains switch approved to IEC 60947-1 incorporated in the electrical installation of the building

Cabling requirements

The TXE device ships with the following cables:

- An AC power cable for each of the two power supplies
- Null modem cable (USB to RJ-45) for the serial console management port

I/O modules

TXE devices support both standard I/O modules and bypass I/O modules. Refer to the following table for fiber and copper components.

Bypass I/O modules are zero-power high-availability (ZPHA) modules that permit network traffic and services while bypassing the device entirely when the device loses power.

TABLE 2-1. Standard I/O Modules

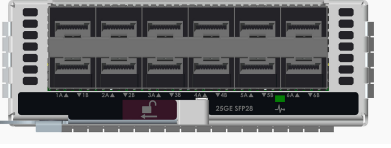
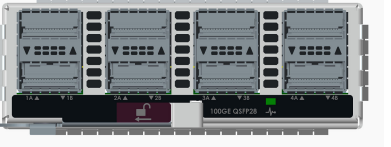

MODULE PART NUMBER	MODULE DESCRIPTION	TRANSCEIVER DESCRIPTION
<p data-bbox="198 321 299 342">TPNN0370</p> 	<p data-bbox="624 321 743 397">6-Segment 25/10/1 GbE SFP28</p>	<p data-bbox="799 321 1091 418">Part Number: TPNN0384 TippingPoint 25 GbE SFP28 SR Transceiver</p> <p data-bbox="799 440 1091 537">Part Number: TPNN0385 TippingPoint 25 GbE SFP28 LR Transceiver</p> <p data-bbox="799 558 1091 656">Part Number: TPNN0057 TippingPoint 10 GbE SFP+ SR Transceiver</p> <p data-bbox="799 677 1091 774">Part Number: TPNN0058 TippingPoint 10 GbE SFP+ LR Transceiver</p> <p data-bbox="799 795 1091 893">Part Number: TPNN0054 TippingPoint 1 GbE SFP RJ45 Transceiver (Copper)</p> <p data-bbox="799 914 1091 1011">Part Number: TPNN0055 TippingPoint 1 GbE SFP SX Transceiver</p> <p data-bbox="799 1032 1091 1130">Part Number: TPNN0056 TippingPoint 1 GbE SFP LX Transceiver</p>
<p data-bbox="198 1170 299 1192">TPNN0371</p> 	<p data-bbox="624 1170 736 1247">4-Segment 100/40 GbE QSFP28</p>	<p data-bbox="799 1170 1091 1268">Part Number: TPNN0382 TippingPoint 100 GbE QSFP28 SR4 Transceiver</p> <p data-bbox="799 1289 1091 1386">Part Number: TPNN0383 TippingPoint 100 GbE QSFP28 LR4 Transceiver</p>

MODULE PART NUMBER	MODULE DESCRIPTION	TRANSCEIVER DESCRIPTION
		Part Number: TPNN0067 TippingPoint 40 GbE QSFP+ SR4 Transceiver
		Part Number: TPNN0327 TippingPoint 40 GbE QSFP+ LR4 Transceiver

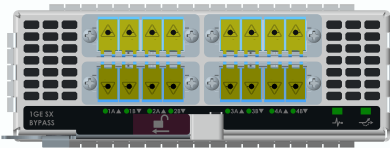
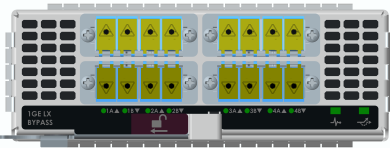
TABLE 2-2. Bypass I/O Modules

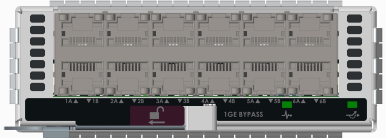
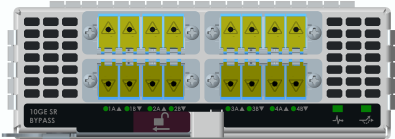
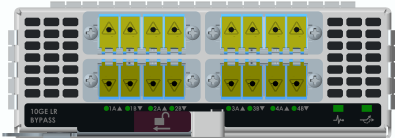
MODULE PART NUMBER	MODULE DESCRIPTION
TPNN0412 	4-Segment 1 GbE SX Bypass
TPNN0413 	4-Segment 1 GbE LX Bypass

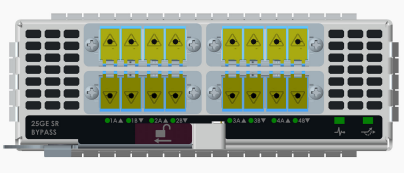
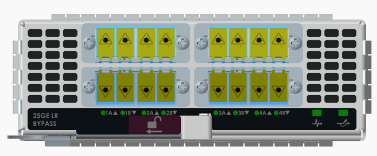
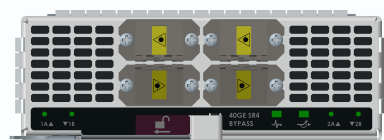
MODULE PART NUMBER	MODULE DESCRIPTION
<p data-bbox="196 253 299 277">TPNN0414</p>  <p>The image shows a TPNN0414 module, a 6-Segment Gig-T Bypass. It is a long, narrow metal chassis with a black front panel. The front panel features six RJ45 ports arranged in two rows of three. The top row is labeled '10G T1', '10G T2', and '10G T3'. The bottom row is labeled '10G T4', '10G T5', and '10G T6'. A '10G BYPASS' button is located in the center of the front panel. There are also two green LEDs on the right side of the front panel.</p>	<p data-bbox="653 253 884 280">6-Segment Gig-T Bypass</p>
<p data-bbox="196 643 299 667">TPNN0410</p>  <p>The image shows a TPNN0410 module, a 4-Segment 10 GbE SR Bypass. It is a long, narrow metal chassis with a black front panel. The front panel features four RJ45 ports arranged in two rows of two. The top row is labeled '10G SR1' and '10G SR2'. The bottom row is labeled '10G SR3' and '10G SR4'. A '10G SR BYPASS' button is located in the center of the front panel. There are also two green LEDs on the right side of the front panel.</p>	<p data-bbox="653 643 928 670">4-Segment 10 GbE SR Bypass</p>
<p data-bbox="196 935 299 959">TPNN0411</p>  <p>The image shows a TPNN0411 module, a 4-Segment 10 GbE LR Bypass. It is a long, narrow metal chassis with a black front panel. The front panel features four RJ45 ports arranged in two rows of two. The top row is labeled '10G LR1' and '10G LR2'. The bottom row is labeled '10G LR3' and '10G LR4'. A '10G LR BYPASS' button is located in the center of the front panel. There are also two green LEDs on the right side of the front panel.</p>	<p data-bbox="653 935 928 963">4-Segment 10 GbE LR Bypass</p>

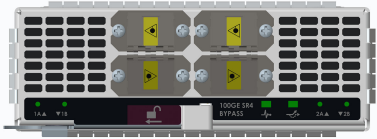
MODULE PART NUMBER	MODULE DESCRIPTION
<p>TPNN0374</p> 	<p>4-Segment 25 GbE SR Bypass</p>
<p>TPNN0375</p> 	<p>4-Segment 25 GbE LR Bypass</p>
<p>TPNN0408</p> 	<p>2-Segment 40GbE SR4 Bypass</p>
<p>TPNN0409</p> 	<p>2-Segment 40GbE LR4 Bypass</p>
<p>TPNN0372</p> 	<p>2-Segment 100 GbE SR4 Bypass</p>

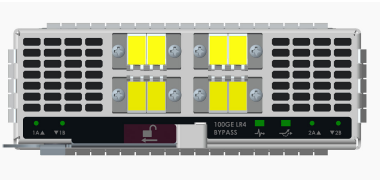
MODULE PART NUMBER	MODULE DESCRIPTION
<p>TPNN0373</p> 	<p>2-Segment 100 GbE LR4 Bypass</p>



CAUTION!

Handle all I/O modules with care. The bypass modules contain mechanical switches that are very sensitive to handling when not installed in the system. Network disruption can occur if handled improperly.

For information on module LEDs, and on preparing, installing, and swapping TippingPoint I/O modules, refer to *I/O Modules Overview (TPS TXE Devices)* on the Trend Micro Online Help Center.

Technical specifications

TXE devices have the following specifications.

SPECIFICATION	DESCRIPTION
<p>Dimensions (unpackaged)</p>	<p>9200TXE: 1.73 (H) in x 18.54 (W) in x 34.10 (D) in (44 mm x 471 mm x 866 mm) 8600TXE: 1.73 (H) in x 18.54 (W) in x 28.90 (D) in (44 mm x 471 mm x 866 mm)</p>
<p>Weight</p>	<p>9200TXE: 42 lbs (19 kg) 8600TXE: 32 lbs (14.5 kg)</p>

SPECIFICATION	DESCRIPTION
AC Power Requirements	<p>9200TXE:</p> <ul style="list-style-type: none"> • Voltage: 100 to 240 • Current: 15 A to 10 A • Frequency 47 to 63 Hz (Tolerance: 50 Hz to 60 Hz) <p>The device's maximum power consumption is 1300 W.</p> <p>8600TXE:</p> <ul style="list-style-type: none"> • Voltage: 100 to 240 • Current: 12 A • Frequency 47 to 63 Hz (Tolerance: 50 Hz to 60 Hz) <p>The device's maximum power consumption is 1000 W</p>
Service Provider operating requirements	<p>Temperature: 32 to 104° F (0 to 40° C) — Operating</p> <p>Temperature: -4 to 158° F (-20 to 70° C) — Storage</p> <p>Altitude: No degradation up to 6561 feet (2000 m)</p> <p>Humidity: 5% to 95% (noncondensing)</p>
External interfaces	<ul style="list-style-type: none"> • One 1 GbE copper management port • One 25 GbE management port • One RJ45 console port • Dual QSFP28-DD (400 Gbps Full-Duplex Total) special purpose ports • Two IOM network slots • One SSD slot

Chapter 3

TPS 1100TX and 5500TX devices overview

The following topics describe the components, chassis, requirements, and installation specifics of the TPS 1100TX and 5500TX devices:

- *Chassis – front panel on page 3-2*
- *Chassis – rear panel on page 3-3*
- *Chassis – features on page 3-3*
- *Model requirements on page 3-6*
- *I/O modules on page 3-7*
- *Technical specifications on page 3-7*

Learn more on page 7-1 about installing the device. Prior to installation, have the *TPS CLI Reference* available for configuration information.

Chassis – front panel

Refer to the following illustration for a front panel view of the TPS 1100TX and 5500TX devices:

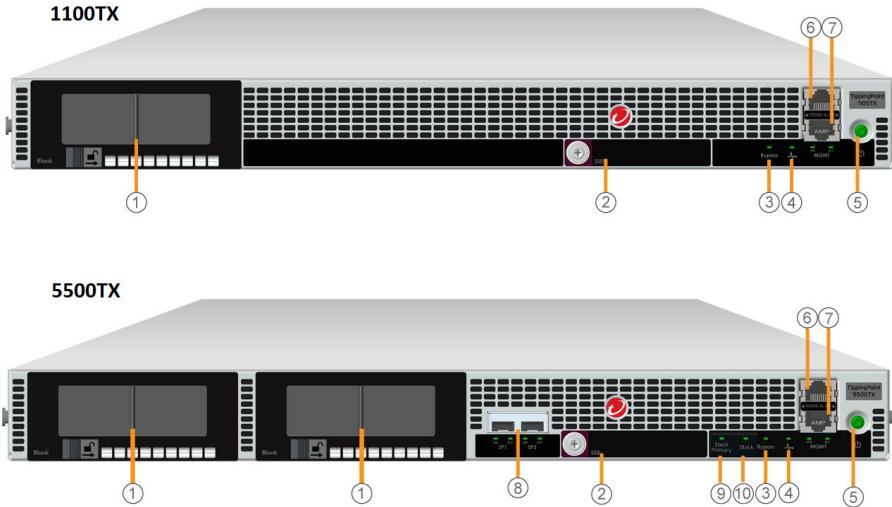

1. I/O modules
2. External storage 1.8-inch SSD (1100TX: 8 GB, 5500TX: 32 GB)
3. Bypass LED
4. Health LED
5. Power button
6. RJ-45 console port
7. GbE management port
8. Special purpose (SP) ports (not used in this TOS release)
9. Stack Primary LED (not used in this TOS release)

- Stack LED (not used in this TOS release)

Chassis – rear panel

Refer to the following illustration for a rear panel view of the TPS 1100TX and 5500TX devices:

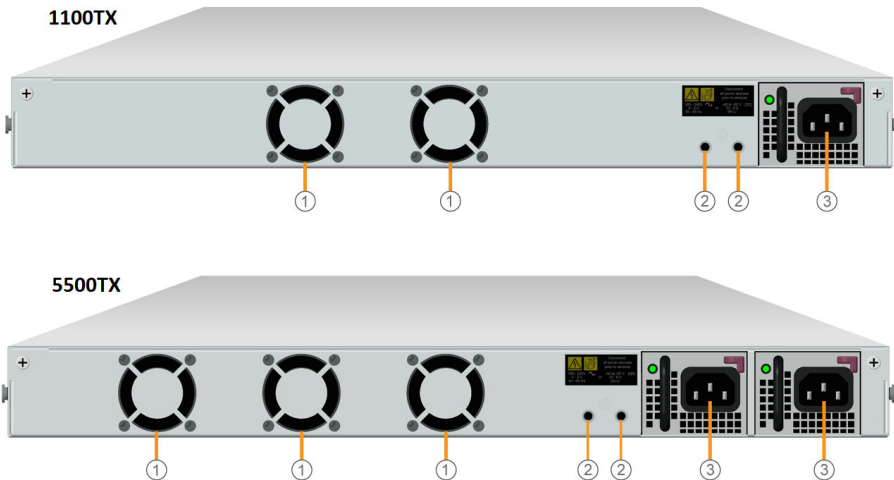

- Fans
- DC grounding lug screw holes (not used in this TOS release)
- Power supplies

Chassis – features

Refer to the following topics for information about the TPS 1100TX and 5500TX chassis features:

- [Fans and power supplies on page 3-4](#)
- [External SSD on page 3-4](#)

- [Ports on page 3-4](#)
- [Chassis LEDs on page 3-5](#)

Fans and power supplies

The TPS 1100TX device includes:

- One replaceable power supply
- Two nonreplaceable fans

The 5500TX device includes:

- Two replaceable, hot-pluggable power supplies
- Three nonreplaceable fans

Learn more about [Power supplies on page 8-1](#) and [Fans on page 9-1](#).

External SSD

All TPS TX Series devices include an external SSD module that ships pre-installed with your product. The SSD is used to store traffic logs, snapshots, and other system data. You can remove and install the card while the device is running; however, to do so, you must issue the appropriate unmounting, mounting, and preparation commands from the device CLI.

[Learn more on page 11-1](#) about these external user disk commands.

Ports

All TPS TX Series devices come equipped with network slots for standard or bypass I/O modules.

In addition, the device provides a console and management port:

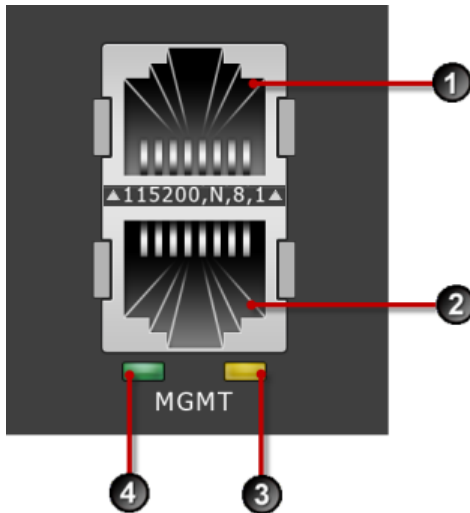

1. 1 RJ-45 serial console port
2. 1 GbE copper management port
3. Activity LED
4. Link LED

Chassis LEDs

When you turn on the device, the system completes a series of component checks and then displays LED indicators to show the status of each component:

- Stack Primary status (5500TX devices; not used in this TOS release)
- Stack status (5500TX devices; not used in this TOS release)
- Bypass status

- Solid red: The device is in Intrinsic High Availability (Intrinsic HA) Layer-2 Fallback (L2FB) mode.
- Off: The device is not in L2FB mode.



System health status

- Flashing green: The system is booting up, and is not yet ready to inspect traffic.
 - Solid green: The system is healthy.
 - Red: The system is experiencing a health alert, such as a fan failure. This state resets to solid green when you view the system log.
- Management port status
 - Link LED: Solid green indicates that the port is linked and ready for data.
 - Activity LED: Flashing amber indicates that the port is passing data.

Model requirements

Refer to the following topics for specific requirements of the TPS 1100TX and 5500TX devices.

- [Power requirements on page 3-6](#)
- [Cabling requirements on page 3-7](#)

Power requirements

The TPS 1100TX and 5500TX devices require Alternating Current (AC) that meets the following requirements:

- Voltage: 100 V to 240 V
- Current: 4 A to 2 A
- Frequency: 47 Hz to 63 Hz (Tolerance: 50 Hz to 60 Hz)

The 1100TX ships with one power supply. The 5500TX device ships with two AC power supplies.

Cabling requirements

The TPS 1100TX and 5500TX devices ship with the following cables:

- An AC power cable for each power supply—one for the 1100TX device, two for the 5500TX device
- Null modem cable (USB to RJ-45) for the serial console management port

I/O modules

[Learn more on page 4-7](#) about the I/O modules for the TPS 1100TX and 5500TX devices.

Technical specifications

The TPS 1100TX and 5500TX devices have the following specifications.

SPECIFICATION	DESCRIPTION
Dimensions (unpackaged)	(1 U form factor) – 1.73 in x 18.54 in x 17.90 in (44 mm x 471 mm x 455 mm)
Weight	<ul style="list-style-type: none"> • 1100TX device – 14.5 lbs (6.58 kg) • 5500TX device – 17.5 lbs (7.94 kg)
AC Power Requirements	<ul style="list-style-type: none"> • Voltage: 100 to 240 • Current: 4 to 2 A • Frequency 47 to 63 Hz (Tolerance: 50 Hz to 60 Hz) <p>The device's maximum power consumption is 250 W.</p>
Service Provider operating requirements	<p>Temperature: 32 to 104° F (0 to 40° C) — Operating</p> <p>Temperature: -4 to 158° F (-20 to 70° C) — Storage</p>
	Altitude: No degradation up to 10,000 feet (3048 m)

SPECIFICATION	DESCRIPTION
	Humidity: 5% to 95% (noncondensing)
External interfaces	<ul style="list-style-type: none">• One 1 GbE copper management port• One RJ-45 console port• (5500TX only) Two fixed 10 GbE SFP+ special purpose (SP) ports (not used in this TOS release)• Network slots:<ul style="list-style-type: none">• 1100TX device – 1 slot• 5500TX device – 2 slots <hr/> <p> Note The second slot supports only the first four segments of a 6-segment I/O module.</p> <hr/> <ul style="list-style-type: none">• 1 SSD slot

Chapter 4

TPS 8200TX and 8400TX devices overview

The following topics describe the components, chassis, requirements, and installation specifics of the TPS 8200TX and 8400TX devices:

- *Chassis – front panel on page 4-2*
- *Chassis – rear panel on page 4-3*
- *Chassis – features on page 4-3*
- *Model requirements on page 5-5*
- *I/O module installation on page 4-7*
- *Technical specifications on page 5-7*

Learn more on page 7-1 about installing the device. Prior to installation, have the *TPS CLI Reference* available for configuration information.

Chassis – front panel

Refer to the following illustration for a front panel view of the 8200TX (1 U) and 8400TX (2 U) devices:

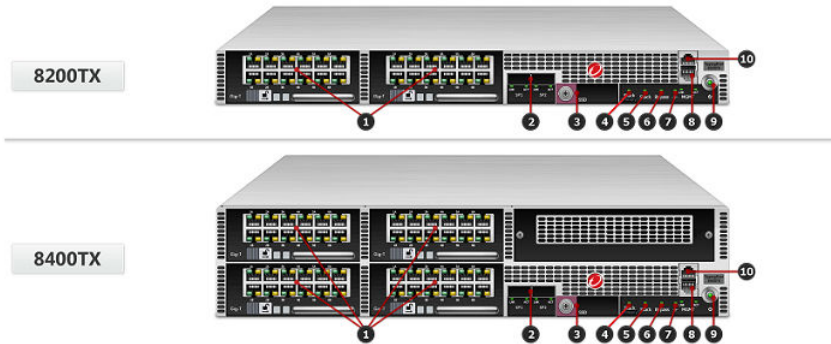

1. I/O modules
2. SP ports
3. External storage 1.8-inch SSD (32 GB)
4. Stack Primary LED
5. Stack LED
6. Bypass LED
7. Health LED
8. GbE management port
9. Power button
10. RJ-45 console port

Chassis – rear panel

Refer to the following illustration for a rear-panel view of the TPS 8200TX and 8400TX devices.

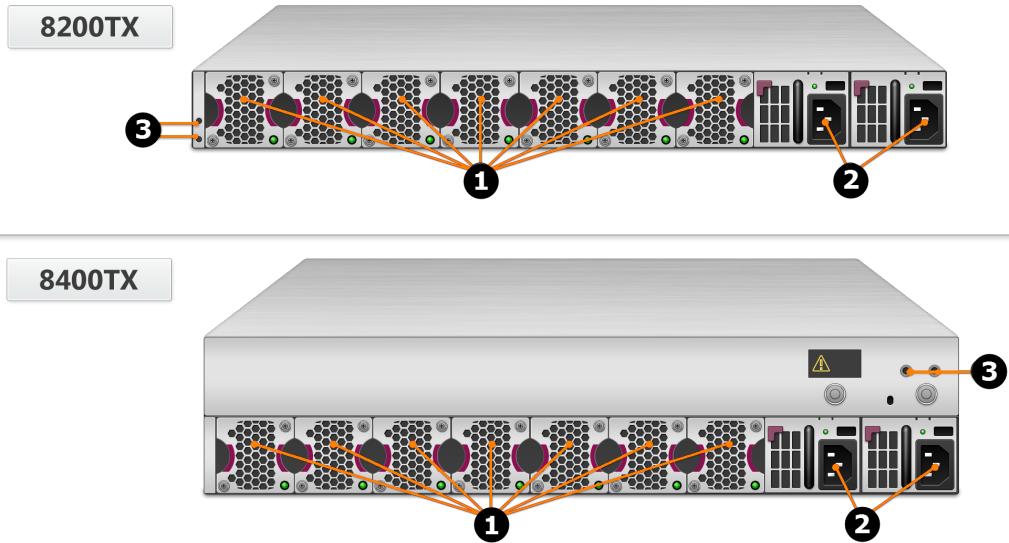

1. Fan modules - fans are numbered from left to right (Fan 1 is on the left; Fan 7 is on the right)
2. Power supply modules (Power supply 1 is on the left; Power supply 2 is on the right)
3. DC grounding lug screw holes

Chassis – features

Refer to the following topics for information about the 8200TX (1 U) and 8400TX (2 U) chassis features:

- [Fans and power supplies on page 4-4](#)

- [External storage card on page 5-4](#)
- [Ports on page 5-5](#)
- [Chassis LEDs on page 4-5](#)

Fans and power supplies

The TPS 8200TX and 8400TX devices include two power supplies and seven cooling fans. You can hot-swap these components. Learn more about [Power supplies on page 8-1](#) and [Fans on page 9-1](#).

External SSD

All TPS TX Series devices include an external SSD module that ships pre-installed with your product. The SSD is used to store traffic logs, snapshots, and other system data. You can remove and install the card while the device is running; however, to do so, you must issue the appropriate unmounting, mounting, and preparation commands from the device CLI.

[Learn more on page 11-1](#) about these external user disk commands.

Ports

All TPS TX Series devices come equipped with network slots for standard or bypass I/O modules.

In addition, the device provides a console and management port:

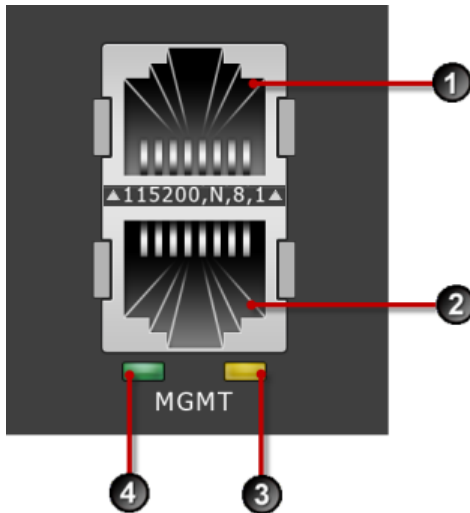

1. 1 RJ-45 serial console port
2. 1 GbE copper management port
3. Activity LED
4. Link LED

Chassis LEDs

When you turn on the device, the system completes a series of component checks and then displays LED indicators to show the status of each component:

- Stack Primary status
 - Solid green: The device is the stack primary.
 - Off: The device is not the stack primary.

- Stack status
 - Amber: The device is not ready to inspect network traffic.
 - Flashing green: The device is RTI but is not currently inspecting network traffic.
 - Solid green: The device is RTI and is inspecting network traffic.
 - Off: Stacking is not enabled on the device.
- Bypass status
 - Solid red: The device is in Intrinsic High Availability (Intrinsic HA) Layer-2 Fallback (L2FB) mode.
 - Off: The device is not in L2FB mode.



System health status

- Flashing green: The system is booting up, and is not yet ready to inspect traffic.
 - Solid green: The system is healthy.
 - Red: The system is experiencing a health alert, such as a fan failure. This state resets to solid green when you view the system log.
- Management port status
 - Link LED: Solid green indicates that the port is linked and ready for data.
 - Activity LED: Flashing amber indicates that the port is passing data.

Model requirements

Refer to the following topics for specific requirements of the TPS 8200TX and 8400TX devices.

- [Power requirements on page 4-7](#)

- [Cabling requirements on page 5-6](#)

Power requirements

The 8200TX and 8400TX devices require Alternating Current (AC) or Direct Current (DC) that meets the following requirements:

- AC: Voltage 100 V to 240 V; 12 A to 6 A; 47 Hz to 63 Hz
- DC: Voltage -40 V to -60 V; 24 A to 16 A

The 8200TX and 8400TX devices ship with two AC power supplies. Consult your TippingPoint account contact for more information if you require a DC power supply.

Cabling requirements

The TPS 8200TX and 8400TX devices ship with the following cables:

- Two AC power cables, one for each hot-swappable power supply
- Null modem cable (USB to RJ-45) for the serial console management port

I/O module installation

Use the following topics to set up the I/O modules supported in TippingPoint security devices:

- [Before you begin on page 4-8](#)
- [ESD requirements on page 4-8](#)
- [I/O module options on page 4-8](#)
- [Module LEDs on page 4-13](#)
- [I/O module replacement on page 4-14](#)
- [Supported transceivers and cables for TippingPoint I/O modules on page 4-15](#)

Before you begin

- Review the release notes for your product for any late-breaking changes to the installation instructions.
- Read and follow all safety information listed in the *TippingPoint Hardware Safety and Compliance Guide* that shipped with your product.
- Complete the installation of your TippingPoint security device.

ESD requirements

Damage from Electrostatic Discharge (ESD) can occur when you handle electronic components improperly. Improper handling can also result in complete or intermittent system failures. Use proper ESD protection whenever you handle equipment. Following these general grounding guidelines:

- Always use an ESD wrist strap when you add or remove components from the chassis.
- Avoid touching the circuit boards or connectors on all cards and modules.
- Avoid contact between the printed circuit boards and clothing. The wrist strap only protects components from ESD voltages on the body. ESD voltages on clothing can still cause damage.

Place a removed component board-side-up on an antistatic surface or in a static-shielding container that is also grounded to the same point as the device. If you plan to return the component to the factory, immediately place it in a static-shielding container.

I/O module options

TippingPoint devices with module slots support both standard I/O modules and bypass I/O modules. Refer to the following table for fiber and copper components.

Only transceiver modules available from Trend Micro have been validated to achieve optimal performance with TippingPoint products. Other vendor



devices are not supported. Using other vendor devices could be detrimental to proper operation of the TippingPoint system.



Bypass I/O modules are zero-power high-availability (ZPHA) modules that permit network traffic and services while bypassing the device entirely when the device loses power.

**Note**



For TX Series devices, consider the following I/O module restrictions:

- Fiber modules do not support auto-negotiation.
 - If you use a 1000-BaseT copper SFP in the 6-Segment GbE SFP module, auto-negotiation will be available at 1 Gbps.
 - 10 GbE SFP+ modules support both SFP and SFP+ transceivers. If you plug SFP transceivers into SFP+ ports, only 1 Gbps speed will be available. Both 1 Gbps and 10 Gbps speeds can be configured with a multispeed SFP + transceiver.
-



STANDARD I/O MODULES	BYPASS I/O MODULES
<p data-bbox="196 253 354 280">6-Segment Gig-T</p>  <p data-bbox="196 540 521 568">Ports: 12 Fixed RJ-45 copper ports</p> <p data-bbox="196 583 485 610">Port speed: 10/100/1000 Mbps</p> <p data-bbox="196 628 536 654">Part number: TPNN0059/TPNN0196</p> <hr/> <p data-bbox="202 704 260 753"> Note</p> <p data-bbox="276 737 626 829">The second slot of the 5500TX device supports only the first four segments of a 6-segment I/O module.</p>	<p data-bbox="653 253 959 280">4-Segment Gig-T Bypass Module</p>  <p data-bbox="653 540 852 568">Ports: 8 copper ports</p> <p data-bbox="653 583 942 610">Port speed: 10/100/1000 Mbps</p> <p data-bbox="653 628 885 654">Part number: TPNN0070</p>

STANDARD I/O MODULES	BYPASS I/O MODULES
<p data-bbox="292 256 481 280">6-Segment GbE SFP</p>  <p data-bbox="292 542 471 566">Ports: 12 SFP ports</p> <p data-bbox="292 586 471 610">Port speed: 1 Gbps</p> <p data-bbox="292 630 525 654">Part number: TPNN0068</p> <hr/> <p data-bbox="299 708 357 756"> Note</p> <p data-bbox="370 740 720 829">The second slot of the 5500TX device supports only the first four segments of a 6-segment I/O module.</p>	<p data-bbox="749 256 1153 280">2-Segment 1 G Fiber SR/LR Bypass Module</p>  <p data-bbox="749 464 1150 513">Ports: 4 Multi-Mode (SR)/Single-Mode (LR) Fiber (LC type)*</p> <p data-bbox="749 532 774 557">(1)</p> <p data-bbox="749 581 928 605">Port speed: 1 Gbps</p> <p data-bbox="749 625 1177 649">Part number: TPNN0071 (SR)/TPNN0072 (LR)</p>

(1)*The TX/RX sides of each duplex-LC bulkhead port match those of standard SFPs. The top ports are each TX|RX, and the bottom ports are each RX|TX.

STANDARD I/O MODULES	BYPASS I/O MODULES
<p data-bbox="196 253 424 277">4-Segment 10 GbE SFP+</p>  <p data-bbox="196 540 431 565">Ports: 8 Fiber SFP+ ports</p> <p data-bbox="196 583 388 607">Port speed: 10 Gbps</p> <p data-bbox="196 626 428 651">Part number: TPNN0060</p>	<p data-bbox="653 253 1067 277">2-Segment 10 G Fiber SR/LR Bypass Module</p>  <p data-bbox="653 459 1053 513">Ports: 4 Multi-Mode (SR)/Single-Mode (LR) Fiber (LC type)*</p> <p data-bbox="653 526 677 550">(2)</p> <p data-bbox="653 574 865 599">Port speed: 1/10 Gbps</p> <p data-bbox="653 618 1080 643">Part number: TPNN0073 (SR)/TPNN0074 (LR)</p>

(2)*The TX/RX sides of each duplex-LC bulkhead port match those of standard SFPs. The top ports are each TX|RX, and the bottom ports are each RX|TX.



STANDARD I/O MODULES	BYPASS I/O MODULES
<p data-bbox="292 253 534 277">1-Segment 40 GbE QSFP+</p>  <p data-bbox="292 542 541 566">Ports: 2 Fiber QSFP+ ports</p> <p data-bbox="292 586 485 610">Port speed: 40 Gbps</p> <p data-bbox="292 630 525 654">Part number: TPNN0069</p>	<p data-bbox="749 253 1132 305">1-Segment 40 GbE Fiber SR4/LR4 Bypass Module</p>  <p data-bbox="749 500 807 524">Ports:</p> <ul data-bbox="776 542 1184 638" style="list-style-type: none"> <li data-bbox="776 542 1139 566">• 40 GbE-SR4 – 2 SR4 Multimode Ports <li data-bbox="776 581 1184 638">• 40 GbE-LR4 – 2 LR4 Singlemode Ports (LC Type) <p data-bbox="749 656 942 680">Port speed: 40 Gbps</p> <p data-bbox="749 699 1147 751">Part number: TPNM0131 (SR4)/TPNM0132 (LR4)</p> <hr/> <p data-bbox="753 802 811 862"> Important</p> <p data-bbox="830 837 1157 959">Ensure that you upgrade your TX-Series device to TOS v5.2.0 or later before inserting the 40 GbE bypass module.</p>

**CAUTION!**

Handle all I/O modules with care. The bypass modules contain mechanical switches that are very sensitive to handling when not installed in the system. Network disruption can occur if handled improperly.

Module LEDs

Use the following table to learn about the states of each LED on the I/O module.

FEATURE	LED	COLOR	DESCRIPTION
Module health 	Status	Green Blinking Amber Solid Amber	The module is configured, in service, and in good health. The module has been inserted and powered up, but is not yet recognized by the software. The module is experiencing a fault.
Bypass 	Status	Off Green	Module in bypass. Module in normal mode (not in bypass).

I/O module replacement

On a TPS TX Series device, *hot swapping* allows you to add, remove, or replace an I/O module without shutting down the device. When the device is turned on, you can hot swap an I/O module without interruption to the TPS device.

When you hot swap an I/O module, keep the following points in mind:

- Hot-swapping I/O modules during system initialization is not supported.
- The module port configuration is always reset.
- The module segment configuration, including link-down synchronization, Intrinsic HA, and inspection bypass, is always preserved. If you swap the module with a different type of module, be sure to verify that your segment configuration settings have persisted.

When the device is turned off, *cold swapping* allows you to add, remove, or replace an I/O module as you would when you hot swap. However, when you cold swap an I/O module, if the replacement module type is the same, the module port configuration is preserved.

When the device is managed by the SMS, a delay of up to 1 minute can occur before the SMS recognizes the changed I/O module.

When you insert a bypass I/O module, the bypass I/O module always starts up in bypass mode. A bypass I/O module remains in bypass mode until you remove it from bypass mode through the CLI, LSM, or SMS. For information about how to use normal mode instead of bypass mode, refer to the SMS, LSM, or CLI documentation.

Supported transceivers and cables for TippingPoint I/O modules

For a list of supported transceivers and cables for TippingPoint I/O modules, refer to *I/O Modules Overview (TX Series Devices)* on the Trend Micro Online Help Center.

Technical specifications

The TPS 8200TX and 8400TX devices have the following specifications.

SPECIFICATION	DESCRIPTION
Dimensions (unpackaged)	<ul style="list-style-type: none"> 8200TX device (1 U form factor) – 1.73 in x 18.54 in x 24.84 in (44 mm x 471 mm x 631 mm) 8400TX device (2 U form factor) – 3.46in x 18.54 in x 24.84 in (88 mm x 471 mm x 631 mm)
Weight	<ul style="list-style-type: none"> 8200TX device – 32 lbs (14.5 kg) 8400TX device – 50 lbs (22.7 kg)
Power Requirements	<ul style="list-style-type: none"> AC: Voltage 100 to 240; Current 12 to 6 A; Frequency 47 to 63 Hz (Tolerance: 50 Hz to 60 Hz) DC: Voltage -40 to -60, Current 24 to 16 A, SELV <p>The device's maximum power consumption is 750 W.</p>
Service Provider operating requirements	<p>Temperature: 32 to 104° F (0 to 40° C) — Operating</p> <p>Temperature: -4 to 158° F (-20 to 70° C) — Storage</p>
	Altitude: No degradation up to 10,000 feet (3048 m)
	Humidity: 5% to 95% (noncondensing)

SPECIFICATION	DESCRIPTION
External interfaces	<ul style="list-style-type: none">• One 1 GbE copper management port• One RJ-45 console port• Two fixed QSFP+ special purpose (SP) ports• Network slots:<ul style="list-style-type: none">• 8200TX device – 2 slots• 8400TX device – 4 slots• 1 SSD slot

Chapter 5

TPS 2200T device overview

The following topics describe the components, chassis, requirements, and installation specifics of the TPS 2200T device:

- *Chassis – front panel on page 5-2*
- *Chassis – rear panel on page 5-3*
- *Chassis – features on page 5-3*
- *Model requirements on page 5-5*
- *Pluggable transceivers on page 5-6*
- *Technical specifications on page 5-7*

Learn more on page 7-1 about installing the device. Prior to installation, have the *TPS CLI Reference* available for configuration information.

Chassis – front panel

Refer to the following illustration for a front panel view of the TPS 2200T 2 U form-factor device:

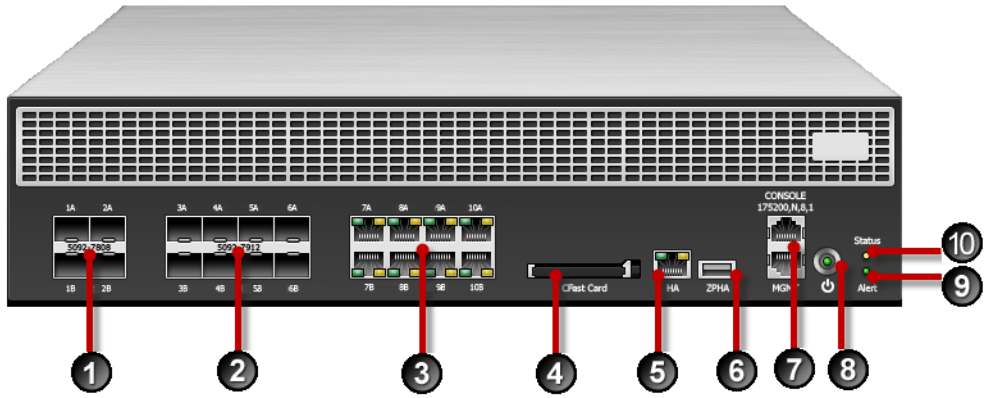

1. 10 GbE SFP+ ports
2. 1 GbE SFP ports
3. 1 GbE copper ports
4. External CFast card
5. Dedicated HA port
6. External ZPHA port
7. Console/Management port
8. Power button
9. Alert indicator
10. System status indicator

Chassis – rear panel

Refer to the following illustration for a rear-panel view of the TPS 2200T device.

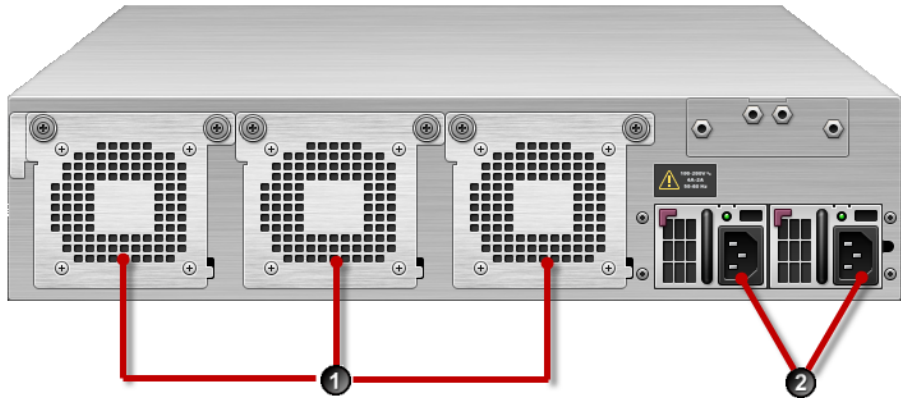

1. Fans (3)
2. Power supplies (2)

Chassis – features

Refer to the following topics for information about the TPS 2200T chassis features:

- [System status indicator on page 5-4](#)
- [Alert indicator on page 5-4](#)
- [Fans and power supplies on page 5-4](#)
- [External storage card on page 5-4](#)
- [Ports on page 5-5](#)

System status indicator

Refer to the System Status indicator on the right side of the front panel to learn about the current operating status of the device.

- **Flashing Green** — Device is booting and is not yet ready to inspect traffic.
- **Solid Green** — Device is running in a healthy state.
- **Solid Yellow** — Device is running but has a health rating below the acceptable threshold.

Alert indicator

Refer to the Alert indicator on the right side of the front panel to learn whether the device is in L2FB mode or not.

- **Solid Yellow** — Device is in L2FB (including when rebooting).
- **Off** — Device is not in L2FB.

Fans and power supplies

The 2200T device includes two hot-swappable power supplies. [Learn more on page 8-1](#) about these power supplies.

The 2200T device includes three cooling fans. The fans for the 2200T device are redundant but *not* hot-swappable. If a failure to a fan module occurs, you must replace the entire device. [Learn more on page 9-1](#) about fans.

External storage card

The TPS 2200T device includes a CFast card slot. The external storage card is used to store traffic logs, snapshots, and other system data. You can remove and insert the card while the device is running; however, to do so, you must issue the appropriate unmounting, mounting, and preparation commands from the device CLI.

For more information, see [External user disk on page 11-1](#) or the *TPS CLI Reference* for command syntax.

Ports

The TPS 2200T device provides a console and management port as shown in the following figure.

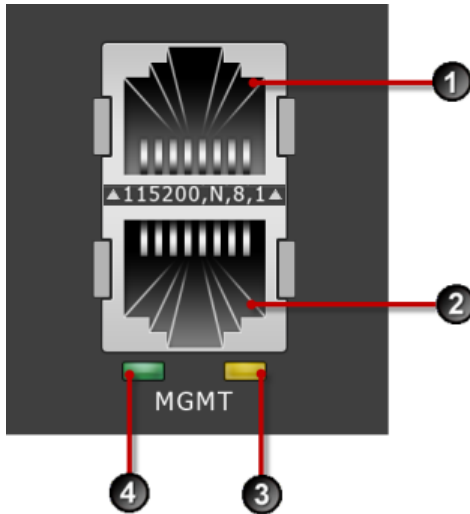

1. 1 RJ-45 serial console port
2. 1 GbE copper management port
3. Activity LED
4. Link LED

In addition, the 2200T device comes equipped with eight 1G copper ports, eight 1G SFP ports, and four 10G SFP+ ports. An external ZPHA device provides ZPHA bypass support for SFP/SFP+.

Model requirements

Refer to the following topics for specific requirements of the TippingPoint 2200T device.

- [Power requirements on page 5-6](#)
- [Cabling requirements on page 5-6](#)

Power requirements

The TPS 2200T device requires Alternating Current (AC) that meets the following requirements:

- AC: Voltage 100 V to 240 V; 12 A to 6 A; 47 Hz to 63 Hz

The TPS 2200T device ships with two AC power supplies.

Cabling requirements

The TPS 2200T device ships with the following cables:

- Two AC power cables, one for each hot-swappable power supply
- Null modem cable (USB to RJ-45) for the serial console management port

Pluggable transceivers

Use any of the following SFP and SFP+ pluggable transceivers with the TPS 2200T device:

- 1G SFP RJ45 T (Copper SFP)
- 1G SFP LC LX 10km 1310nm XCVR
- 1G SFP LC SX 550m 850nm XCVR
- 10G SFP+ LC SR*
- 10G SFP+ LC LR*

*Rate does not include autonegotiation. Dual-rate SFP+ transceivers are not supported.

**Note**

Only transceiver modules available from Trend Micro have been validated to achieve optimal performance with TippingPoint products. Other vendor devices are not supported. Using other vendor devices could be detrimental to proper operation of the TippingPoint system.

The following table details the information for SFP and SFP+ transceivers.

FIBER INPUT	SIGNAL
Left side	Transmit
Right side	Receive

Technical specifications

The TPS 2200T device has the following specifications.

SPECIFICATION	DESCRIPTION
Dimensions (unpackaged)	2 U form factor – 3.46 in (H) x 16.77 in (W) x 18.80 in (D) (8.80 cm x 42.60 cm x 47.80 cm)
Weight	26.26 lbs (11.91 kg)
Power Requirements	AC: Voltage 100 to 240; Current 12 to 6 A; Frequency 47 to 63 Hz The appliance's maximum power consumption is 493 W.
Service Provider operating requirements	Temperature: 32 to 104° F (0 to 40° C) — Operating Temperature: -4 to 158° F (-20 to 70° C) — Storage
	Altitude: No degradation up to 10,000 feet (3048 m)
	Humidity: 5% to 95% (non-condensing)

SPECIFICATION	DESCRIPTION
External interfaces	<ul style="list-style-type: none">• One 1 GbE copper management port• One RJ-45 console port• Eight 1 GbE copper ports• Eight 1 GbE SFP fiber ports• Four 10 GbE SFP+ fiber ports• One HA port• One ZPHA port• One CFast slot

Chapter 6

TPS 440T product overview

The following topics describe the components, chassis, requirements, and installation specifics of the TPS 440T device:

- *Chassis – front panel on page 6-2*
- *Chassis – rear panel on page 6-3*
- *Chassis – features on page 6-3*
- *Model requirements on page 6-5*
- *Technical specifications on page 6-6*

For information about installing the device, *Learn more on page 7-1* about installing the device. Prior to installation, have the *TPS CLI Reference* available for configuration information.

Chassis – front panel

Refer to the following illustration for a front panel view of the TPS 440T device.

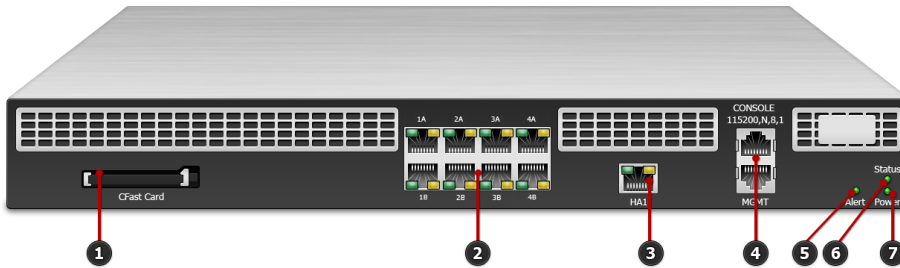

1. CFast card
2. 1 GbE copper ports
3. Dedicated HA port
4. Serial console port/Management port
5. Alert indicator
6. System status indicator
7. Power indicator

Chassis – rear panel

Refer to the following illustration for a rear-panel view of the TPS 440T device.



1. Fans (3)
2. AC power supply
3. AC power connector
4. Power switch

Chassis – features

Refer to the following topics for information about the TPS 440T chassis features:

- [System status indicator on page 6-3](#)
- [Alert indicator on page 6-4](#)
- [Fans and power supplies on page 6-4](#)
- [External storage card on page 6-4](#)
- [Ports on page 6-5](#)

System status indicator

Refer to the System Status indicator on the right side of the front panel to learn about the current operating status of the device.

- **Flashing Green** — Device is booting and is not yet ready to inspect traffic.
- **Solid Green** — Device is running in a healthy state.
- **Solid Yellow** — Device is running but has a health rating below the acceptable threshold.

Alert indicator

Refer to the Alert indicator on the right side of the front panel to learn whether the device is in L2FB mode or not.

- **Solid Yellow** — Device is in L2FB (including when rebooting).
- **Off** — Device is not in L2FB.

Fans and power supplies

The TPS 440T device includes one power supply and three internal cooling fans. These components are not customer-replaceable. [Learn more on page 8-1](#) about these components.

External storage card

The TPS 440T device includes a CFast card slot. The external storage card is used to store traffic logs, snapshots, and other system data. You can remove and insert the card while the device is running; however, to do so, you must issue the appropriate unmounting, mounting, and preparation commands from the device CLI.

[Learn more on page 11-1](#) about the external storage card.

Ports

The TPS 440T device comes equipped with eight copper ports. In addition, the device includes the console and management ports shown in the following figure.

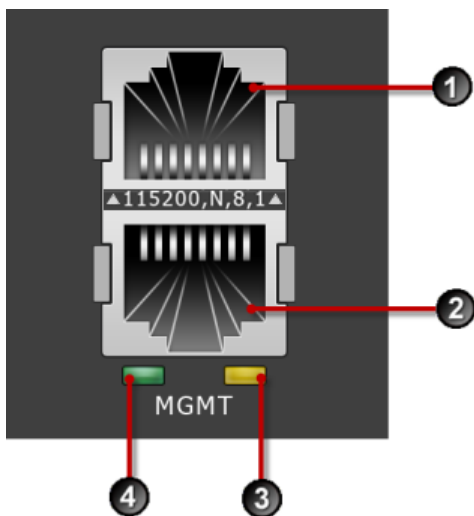

1. 1 RJ-45 serial console port
2. 1 GbE copper management port
3. Activity LED
4. Link LED

Model requirements

Refer to the following topics for specific requirements of the TPS 440T device.

- [Power requirements on page 6-6](#)
- [Cabling requirements on page 6-6](#)

Power requirements

The TPS 440T device requires Alternating Current (AC) that meets the following requirements:

- AC: Voltage 100 V to 240 V; 4 A to 2 A; 47 Hz to 63 Hz

The TPS 440T device ships with one AC power supply.

Cabling requirements

The TPS 440T device ships with the following cables:

- One AC power cable
- Null modem cable (USB to RJ-45) for the serial console management port

Technical specifications

The TPS 440T device has the following specifications.

SPECIFICATION	DESCRIPTION
Dimensions (unpackaged)	1 U form factor – 1.73 in (H) x 16.78 in (W) x 17.72 in (D) (4.40 cm x 42.62 cm x 45.00 cm)
Weight	15.28 lbs (6.93 kg)
Power Requirements	AC: Voltage 100 to 240; Current 4 to 2 A; Frequency 50 to 60 Hz The device's maximum power consumption is 250 W.
Service Provider operating requirements	Temperature: 32 to 104° F (0 to 40° C) — Operating Temperature: -4 to 158° F (-20 to 70° C) — Storage
	Altitude: No degradation up to 10,000 feet (3048 m)
	Humidity: 5% to 95% (non-condensing)

SPECIFICATION	DESCRIPTION
External interfaces	<ul style="list-style-type: none">• One 1 GbE copper management port• One RJ-45 console port• Eight 1 GbE copper ports• One CFast slot

Chapter 7

Install your TPS device

After you have completed preparation procedures and unpacked the TPS device, you can install and configure the components. Have the *TPS CLI Reference* available for configuration information reference. After installation of the hardware components, complete the initial setup wizard as part of the installation and configuration procedures.

Before installing your device, review and adhere to all safety guidelines described the *TippingPoint Hardware Safety and Compliance Guide*, which also contains detailed regulatory compliance information.

Follow these installation procedures:

- [Install the chassis on page 7-3](#)
- [Connect the power supply on page 7-4](#)
- Install the I/O modules
 - [Add the I/O modules – TPS TXE devices on page 7-7](#)
 - [Add the I/O modules – TPS TX Series on page 7-5](#)
- [Attach the cables on page 7-9](#)
- [Turn on the device on page 7-10](#)
- [Run the setup wizard on page 7-10](#)

- *Install your license package on page 7-11*
- *Attach network connections on page 7-12*

Install the chassis

Before installing your new security device, gather any necessary materials and prepare the network and hardware site. To carefully and correctly install the device, read through all preparation instructions and requirements. Use this general guideline information and the Read Me First that shipped with your product for all TippingPoint devices.

To install the device you must complete the following procedures:

- *Determine total rack space on page 7-3*
- *Attach the device to the rack on page 7-3*
- *Connect the power supply on page 7-4*

Determine total rack space

Before you install the chassis, determine the total rack space required to install your system. The total required rack space increases if you plan to install multiple systems.

The device fits in a 19-inch-wide rack (or a 23-inch-wide rack, with appropriate conversion parts available from rack accessory vendors). For more information about the dimensions of the device, refer to the technical specifications and requirements for your model.

Attach the device to the rack

Unpack the accessory kit and the slide rail assembly kit that shipped with your security device.

If the rack comes with stabilizers, install the stabilizers before mounting or servicing the unit in the rack.

If the rack is partially filled, load the rack from the bottom to the top with the heaviest component at the bottom. During initial installation, make sure to evenly distribute the weight so that the rack is stable.

**Important**

Always use a four-post mount for four-post racks. You can optionally order front mounting ears from Trend to install the devices in two-post racks in front-mount or mid-mount positions. For more information, contact your TippingPoint representative.

If you plan to expand your system to include additional TippingPoint systems in the future, allow space in the rack for additions. During the initial installation, keep in mind the weight distribution and stability of the rack.

Connect the power supply

After you have bolted the device to the rack, attach the power supply AC connections. Do not turn on the device until you have completed all of the remaining installation steps.

TXE devices require two AC power supplies for operation. For maximum protection, use different power circuit feeds for each power cord.

The TPS 2200T, 5500TX, 8200TX, and 8400TX security devices require the use of one power cord to turn on the device. Use a second power cord for redundancy. For maximum protection, use different power circuit feeds for each power cord.

The TPS 440T and 1100TX devices provide a single power supply.

When you install DC power, always install the safety ground cable before connecting the power supply. For DC power connection details, refer to the *Install your power supply module* documentation.

To connect the power supply

Procedure

1. Locate the power inlets on the back of the chassis.
 2. Plug the female end of a standard power cord into the power inlet. Plug the other end of the power cord into an AC outlet, power strip, or UPS.
-

Install the external storage card

The external SSD module comes pre-installed in the TXE and TX-Series security devices. If your device is included in either of these models, you can skip this step.

For TPS 440T and 2200T security devices, install the CFast card that was packaged with your product into the empty slot on the front panel of the device. Use this pre-formatted, hot-swappable user disk to store system logs, snapshots, and other system data.

If the device has been set to require authentication for external user disks, complete the mounting process by using the command line interface (CLI). [Learn more on page 11-4.](#)

Add the I/O modules – TPS TX Series

TPS TX Series devices come with blank modules inserted into I/O module slots. The 1100TX device provides one I/O slot, the 5500TX and 8200TX devices provide two I/O slots, and the 8400TX device provides four I/O slots.



WARNING!

Do not leave slots empty for an extended period of time. Insert a blank module or I/O module so that the device can be correctly cooled. [Learn more on page 4-7](#) about I/O module installation.

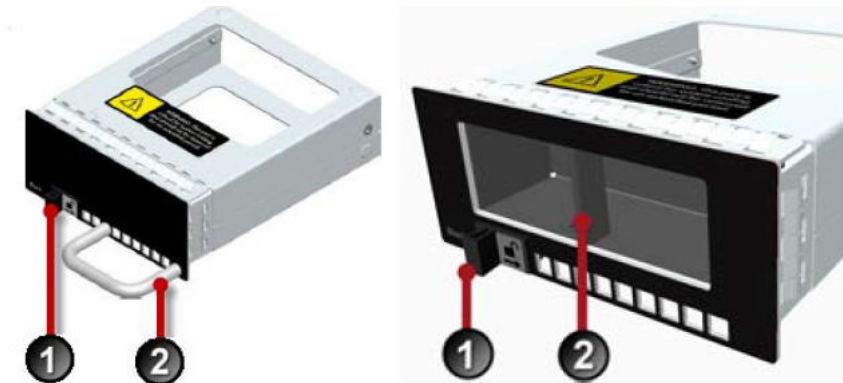

Procedure

1. To remove the blank module, slide the slide latch (1) to the right and pull on the handle (2 on left module) or grab point (2 on right module).



CAUTION!

Never lift your device using the module handles.

2. To insert an I/O module, slide the module into the empty module slot.
When the module is in the correct position, the slide latch automatically slides into position.

When you insert a bypass I/O module, the bypass I/O module always starts up in bypass mode. A bypass I/O module remains in bypass mode until you remove it from bypass mode through the CLI, LSM, or SMS. For information about how to use normal mode instead of bypass mode, refer to the SMS, LSM, or CLI documentation.

Add the I/O modules – TPS TXE devices

Before you begin

- Review the release notes for your product for any late-breaking changes to the installation instructions.
- Read and follow all safety information listed in the *TippingPoint Hardware Safety and Compliance Guide* that shipped with your product.
- Complete the installation of your TippingPoint security device.

Damage from Electrostatic Discharge (ESD) can occur when you handle electronic components improperly. Improper handling can also result in complete or intermittent system failures. Use proper ESD protection whenever you handle equipment. Follow these general grounding guidelines:

- Always use an ESD wrist strap when you add or remove components from the chassis.
- Avoid touching the circuit boards or connectors on all cards and modules.
- Avoid contact between the printed circuit boards and clothing. The wrist strap only protects components from ESD voltages on the body. ESD voltages on clothing can still cause damage.

Devices come with blank modules inserted into the two I/O module slots.



WARNING!

Do not leave slots empty for an extended period of time. Insert a blank module or I/O module so that the device can be correctly cooled.



CAUTION!

Never lift your device using the module handles.

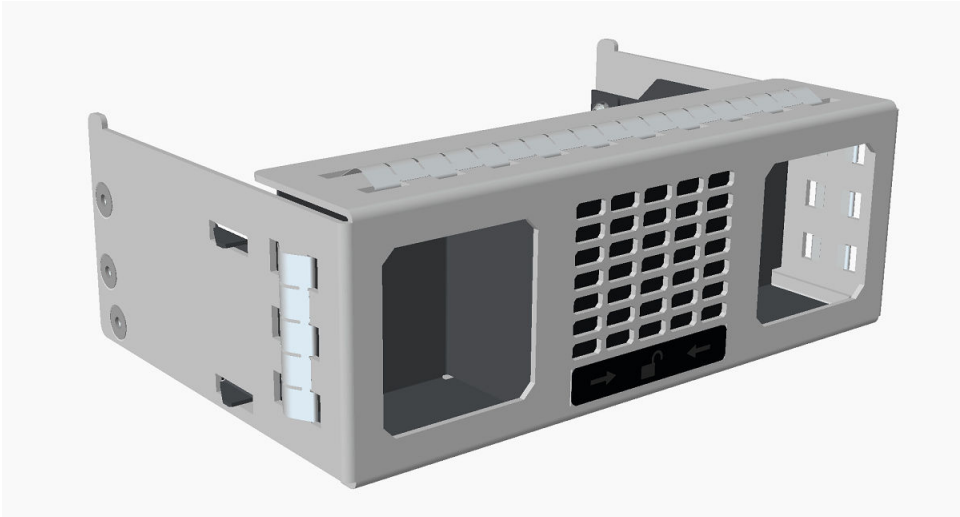

FIGURE 7-1. TXE device blank module

To remove the blank module, use your thumb and finger in each pocket to pinch the release mechanism, and gently pull the module out of its chamber.

To insert an I/O module:

Procedure

1. Unlock the locking lever that is attached to the faceplate at the bottom of the I/O module by pulling it open from the lever's right side.



CAUTION!

The locking lever must be fully opened before inserting a module. Inserting a module without opening the locking lever can cause the module to become stuck in the slot and prevent its removal.

2. Insert the module by sliding it into the empty module slot. When the module is in the correct position, manually close the locking lever to complete the insertion and lock the module in its slot.
-

When you insert a bypass I/O module, the bypass I/O module always starts up in bypass mode. A bypass I/O module remains in bypass mode until you remove it from bypass mode through the CLI or SMS. For information about how to use normal mode instead of bypass mode, refer to the SMS or CLI documentation.

Attach the cables

During initial setup, use the console port to access the setup wizard.

Connect the console port

Procedure

1. Connect the RJ-45 null modem cable to the console port on the front of the unit.
2. Connect the other end of your cable (standard USB connector) to your computer.

Use the following terminal settings for the console port:

- Baud rate: 115.2 Kbps
 - Character size: 8 bits
 - Parity: None
 - Stop Bits: One
 - Flow Control: None
-

Connect the management port

The management port provides Ethernet access to the device for remote management

Before you begin

Install an appropriate transceiver (SFP, SFP+, or SFP28) into the management port in order to use its high-BW capability. To learn more about the available

transceivers, refer to *I/O Modules Overview* on the Trend Micro Online Help Center.

Procedure

1. Connect one end of the Category 5 Ethernet cable to the port labeled MGMT located on the front panel.
 2. Connect the other end of the Ethernet cable to your network. This enables remote management.
-

Turn on the device

After you have reviewed all requirements for operating your product, turn on the device:

- To turn on a TPS 440T device, flip the power switch on the back panel of the device.
- To turn on all other TPS security devices, use the power button located on the front panel of the device.



Important

When you shut down the TippingPoint Operating System (TOS) using the `halt` command, the device still has power. Before you can restart a device in this state, *you must first remove power completely for 60 seconds.*

- For 440T devices, either unplug the device or turn off the power using the power switch on the back panel of the device.
 - For 2200T, TX, and TXE devices, you can remove power by holding down the front panel power button for 5 seconds.
-

Run the setup wizard

From the console terminal, complete the initial configuration by using the setup wizard. The wizard performs system checks and then prompts you to complete the initial setup.

After you run the setup, you can further configure your system using subsequent setup commands through the device CLI. See the *TPS Command Line Interface Reference* for detailed command descriptions.

1. Specify a security level (None, Low, Medium, or High). The security level you select determines your password complexity requirements.
2. Create an administrative account with the **SuperUser** role. The **SuperUser** role gives the account full access to the device. For more information about user accounts, review the SMS or CLI documentation for your product.

The wizard prompts you to log in with your administrative account so that you can continue initial setup.

3. From the console port terminal, log in with your administrative account.

The wizard prompts you to configure IP address, default gateway, DNS server, and timekeeping options.

Install your license package

Install your license package on the device to provide the following product capabilities:

- Inspection throughput
- Digital Vaccine
- ThreatDV
- SSL inspection

You can install the license package using the SMS or, if available on your device, LSM. For information about how to install the license package, refer to the user guide for whichever interface you use.



Important

After you install your license package, if prompted, reboot the device to apply any license updates.

Update your license package to assign a product capability that you have purchased, such as an inspection throughput license, to a particular security device. To review and manage the capabilities in your license package, go to the TippingPoint License Manager on the [TMC](#).

Verify your product license provides sufficient inspection throughput. By default, a TPS security device is unlicensed and provides reduced inspection throughput for testing and evaluation purposes only.

SECURITY DEVICE	UNLICENSED INSPECTION THROUGHPUT
9200TXE /8600TXE	1 Gbps
1100TX	100 Mbps
5500TX	100 Mbps
8400TX	1 Gbps
8200TX	1 Gbps
2200T	200 Mbps
440T	100 Mbps

Attach network connections

Attach your network cables to network segments on the device where appropriate.

Where to go next

After you attach network connections, network traffic passes through the device using the default filter configuration. The default configuration automatically recognizes and blocks traffic that is known to be malicious at all times, under all conditions, in all network environments.

On devices with I/O modules, any bypass I/O modules remain in bypass mode until you remove them from bypass mode through the CLI, SMS, or, if available, LSM. For information about how to disable bypass mode, refer to the SMS, LSM, or CLI documentation.

To complete your installation, refer to the *Release Notes* for your product. The *Release Notes* provide the latest post-installation information for your product.

You can perform additional configuration, administrative, and management tasks, by using:

- The device CLI or, if available, LSM. The LSM and CLI enable straightforward management of a particular device.

**Note**

From the CLI, you can repeat the setup wizard by using the **setup** command. When you use the CLI, configure the terminal emulation package to transmit a Ctrl-H character when the Backspace key is pressed.

-
- The SMS. The SMS provides a scalable, policy-based operational model, and enables straightforward management of large-scale IPS and TPS deployments.

Chapter 8

Power supplies

The following topics provide information for using the power supply modules:

- *AC power supply – TPS 2200T, TX, and TXE devices on page 8-2*
- *DC power supply – TPS TX and TXE devices on page 8-5*



WARNING!

Your product might have more than one power supply source. All power sources must be removed to de-energize the unit.

The TPS 2200T device has hot-swappable power supplies; there are no other serviceable parts inside. There are no hot-swappable or serviceable parts inside the TPS 440T device.

AC power supply – TPS 2200T, TX, and TXE devices

The TPS 1100TX device includes one replaceable power supply module.

The TPS 2200T, 5500TX, 8200TX, 8400TX, and 9200TXE devices include two power supply modules. These modules are hot-swappable, redundant, and current-sharing, and the appliance can run with one active module.

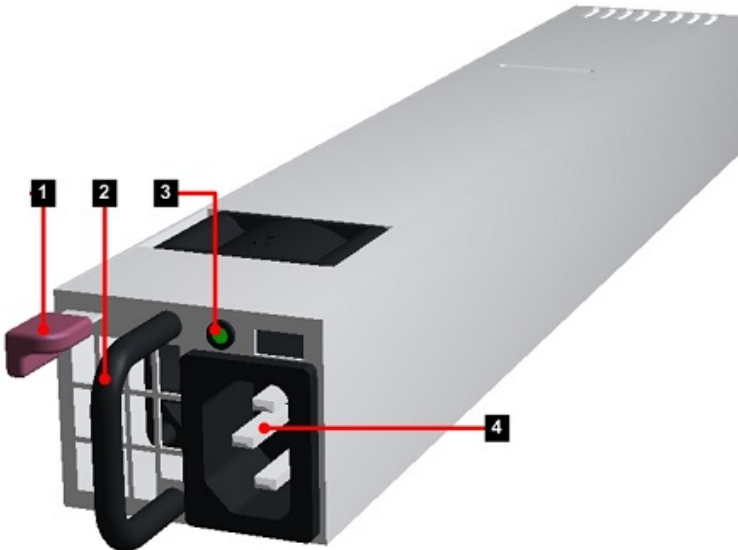

FIGURE 8-1. T and TX power supply module

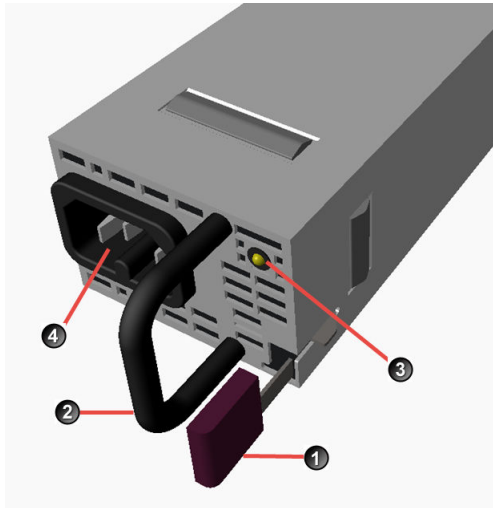

FIGURE 8-2. TXE power supply module

1. Removal Latch
2. Handle
3. Status LED
4. AC male power input

The Status LED is green when the module is powered and running normally.

For a TXE device, each power module comes with an integrated strain relief clip, as shown in the following illustration, that enables you to prevent the power cords from being too obtrusive. It also helps to reduce strain on the power cord and power supply outlets.



FIGURE 8-3. Retention clip for TXE power modules

Connect the AC power supply

When the AC power supply has been securely placed in the device, use the following procedure to connect power to the AC power supply:

Procedure

1. Locate the male power input on the back of the chassis.
2. Plug one end of a standard female power plug into the power input.
3. Plug the other end into an AC outlet, power strip, or UPS. Learn more about the power requirements for your product:
 - TXE devices – [Technical specifications on page 2-12](#)
 - 1100TX and 5500TX devices – [Technical specifications on page 3-7](#)
 - 8200TX and 8400TX devices – [Technical specifications on page 4-15](#)
 - 2200T device – [Technical specifications on page 5-7](#)
 - 440T device – [Technical specifications on page 6-6](#)

Except for the TXE devices, all TPS devices return to their previous power-on state in the event of a power interruption. If power was on when the interruption occurred, the devices automatically power back

on when the power is reconnected; if power was off, the devices stay off when the power is reconnected.

A TXE device automatically powers on whenever the power is connected. You can configure this behavior using the BIOS setup menu.

DC power supply – TPS TX and TXE devices

All TX devices are NEBS compliant and can accept a combination of AC and DC power supply units.

TXE devices can accept both AC and DC power supply units, but not at the same time. DC-powered equipment is not provided with a mains switch. For these products, an all-pole mains switch approved to IEC 60947-1 should be incorporated in the electrical installation of the building.

Consult your TippingPoint account contact for more information on obtaining DC power supplies.



WARNING!

Do not attempt to install a DC power supply into a 440T device. The 440T device does not contain the grounding capability for safe installation of a DC power supply. Bodily harm and damage to the system could result.

Connect the DC power supply



WARNING!

When installing the product, always make the ground connection before applying power to the unit. You must ground this equipment to an external ground connection. Use a green and yellow 8 AWG ground wire to connect the host to earth ground during normal use. Disconnect the ground connection only after the unit is completely powered down.



CAUTION!

Do not attach a ground wire to the ground screw on the DC power supply module. Attach the ground wire to the DC grounding screw holes (0.63-inch hole spacing) with #10 screws. The DC grounding screw holes are located in the rear of the chassis.

The power supply LED is green when the module is powered and running normally.

When the DC power supply has been securely placed in the device, use the following procedure to connect power to the DC power supply.

Procedure

1. Locate the ground screw on the back of the chassis.

Refer to the following figures for the location.

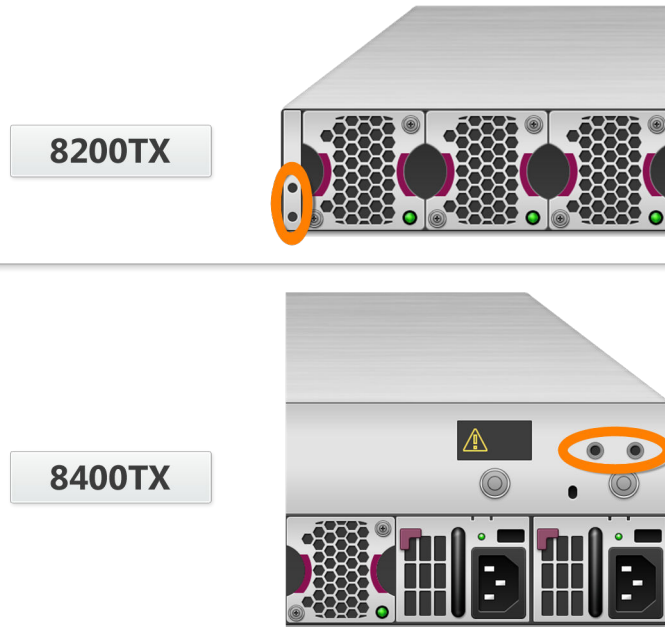

FIGURE 8-4. Ground screw location for TX devices

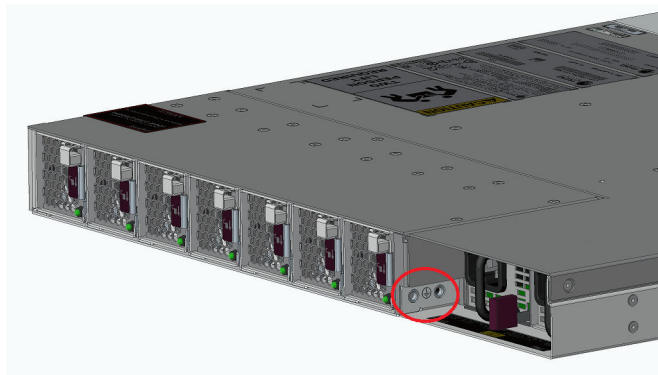

FIGURE 8-5. Ground screw location for 9200TXE devices

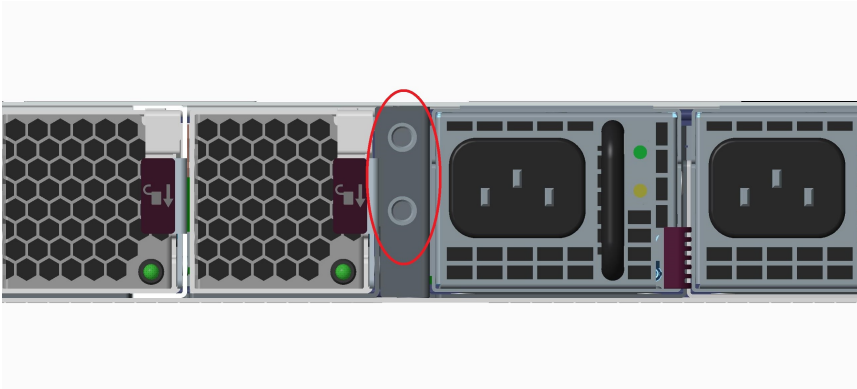

FIGURE 8-6. Ground screw location for 8600TXE devices

2. Attach a 8 AWG ground wire to the chassis ground strap mounting.
The wire should be crimped with a ring lug.

3. Locate the power input terminal block on the back of the module.

4. Attach the 8 AWG DC power wires to the power input terminal block labeled -48V and RTN.

The power wires should be crimped with lug spades to ensure a secure connection.

5. Connect the other side of the power cable to the SELV power source.

The power source should meet the following requirements:

- Voltage: -40 to -60 V
- Amps:
 - TX: 24 to 16
 - 9200TXE: 50 (maximum)
 - 8600TXE: 30 (maximum)
- SELV

6. Depending on the BIOS settings and the state the device was in when the power was unplugged, the device might or might not turn on

automatically when you reapply power. If necessary, power on the device with the button on the front of the chassis.

Chapter 9

Fans

The 440T device includes five cooling fans (two of them are internal). The fans are not redundant or hot-swappable. If a failure to a fan module occurs, you must replace the entire device.

The 1100TX device includes two nonreplaceable cooling fans.

The 2200T and 5500TX devices include three cooling fans. The fans for these models are redundant but not replaceable. If a failure to a fan module occurs, you must replace the entire device.

The 8200TX, 8400TX, and TXE devices include seven cooling fans. The fans for these models are redundant and hot-swappable. You can replace an individual fan without powering down the device.

Spare fans for TX devices (TPNN0266) and TXE devices (TPNN0377) are replacement units and can only be used with their corresponding devices.

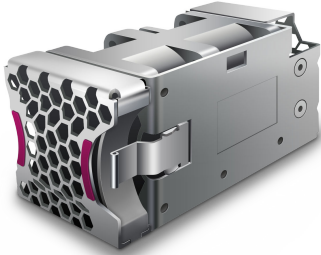

FIGURE 9-1. TX device fan

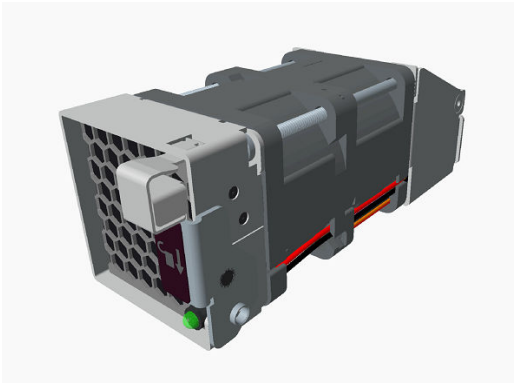

FIGURE 9-2. TXE device fan

When a fan module fails or its RPM rate falls below a certain threshold, the system generates a warning or critical alarm message in its logs.

You can check fan performance by using:

- The LSM (T and TX devices only): **System Health > Monitor > Fan Speed**
- The device CLI: `show health fan`

Replace the fan – 8200TX, 8400TX, and TXE devices only

The TPS 8200TX, 8400TX, and TXE fan modules are hot-swappable and you can replace them when the device is operating.

After you identify the faulty fan module, follow these steps to replace the fan module. The fan modules are hot-swappable and can be replaced when the device is operating.

1. Press the release tab on the right side of the fan module and pull the module from its slot.
2. Set the faulty fan module aside.
3. Remove the new fan module from the packaging.
4. Align the new fan module with its open slot, and then slide the unit in until it is seated in the connector.

After you insert the fan module, the system verifies the fan speed. You can manually verify the performance of TX fans by using the LSM: **System Health > Monitor > Fan Speed**.

Chapter 10

Power cord retention bracket

**Note**

The power cord retention bracket is included with T and TX power modules only. For TXE devices, each power module comes instead with an integrated strain relief clip. [Learn more on page 8-2.](#)

The power cord retention bracket prevents the power cords from being too obtrusive. It also helps reduce strain on the power cord and power supply outlets.



Use the information in the following topics to manage the power cord retention bracket:

- *Install the retention bracket on page 10-3*
- *Attach the power cord retention bracket on page 10-3*
- *Remove the bracket on page 10-4*

Install the retention bracket

The following figure shows the back panel of a TPS 2200T device with the power cord retention bracket installed:

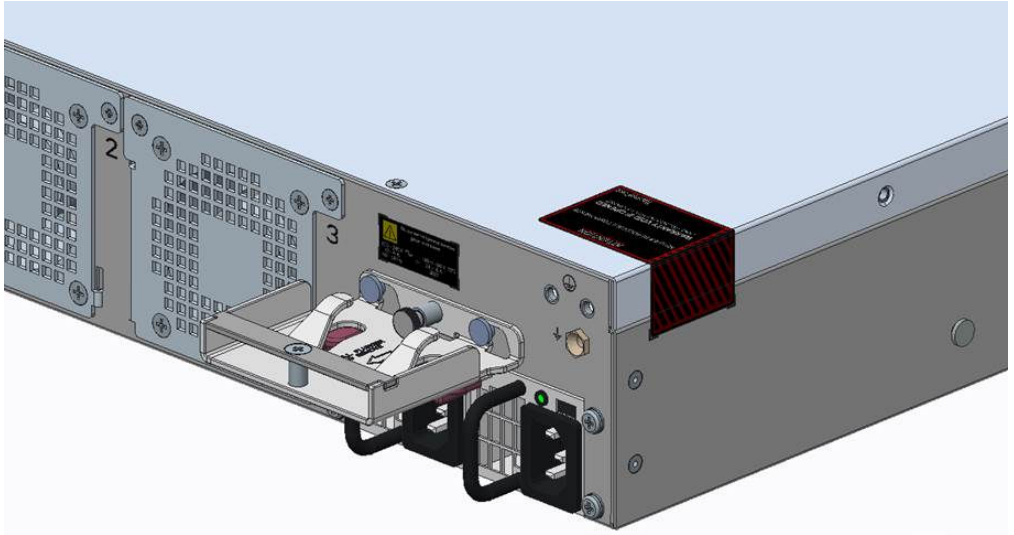

To install the retention bracket:

Procedure

1. Orient the bracket against the back surface of the chassis.
 2. Slide the bracket over the two shoulder rivets on the back of the chassis.
The spring-loaded plunger in the center of the bracket slides into place.
-

Attach the power cord retention bracket

Follow this procedure to attach the power cord to the retention bracket:

Procedure

1. Fold the power cable and slide it into the slot.
 2. Push the folded cable into the slot until the cable loop goes past the sheet metal tabs.
 3. Secure the folded cable loop under the sheet metal tabs and attach the power cable to the power supply.
-

Remove the bracket

If you need to remove one of the brackets, pull the spring-loaded plunger in the middle of the bracket and slide the bracket up and off the shoulder rivets.

Chapter 11

External user disk

The following topics provide information about the external user disk (CFast or SSD):

- *External SSD on page 11-2*
- *External CFast storage card on page 11-3*
- *External user disk commands on page 11-4*

External SSD

In addition to the embedded 32 GB of CFAST storage (8 GB CFAST storage for the 1100TX), the TPS TX Series and TXE Series devices come with a preformatted external GB SSD module for storing traffic logs, snapshots, and other system data. The SSD storage capacity for each model is as follows:

- 1100TX – 8 GB
- 1500TX – 32 GB
- 8200TX – 32 GB
- 8400TX – 32 GB
- 9200TXE/8600TXE – 240 GB

Only SSDs available from Trend Micro have been validated to achieve optimal performance with TippingPoint products. Other vendor drives are not supported. Using other vendor drives could be detrimental to proper operation of the TippingPoint system.

The SSD module is not designed to be removed on a regular basis.

If you replace the SSD module while the device is turned off, be sure to also restore power to the device so that you can mount the replacement disk. Failure to mount the replacement disk prevents the device from automatically mounting the disk when the device is rebooted. The SSD slot is only active if an SSD module is present when the device powers on.

Before you begin, determine whether the SSD module is faulty and needs to be replaced. When the SSD module fails, the system generates a warning or critical alarm message in the System log. To verify the state of the SSD module, run the `show health storage` CLI command, and then review the `/user disk` information. For more information about this command, see the *Command Line Interface Reference*.

**CAUTION!**

Before you remove the SSD, use the device CLI to first unmount the drive. Failure to properly remove the TippingPoint SSD can result in disk corruption and a system error. [Learn more on page 11-4](#) about using the external user disk commands.

To install the replacement SSD module:

1. If the device is turned on, enter the `user-disk unmount` CLI command to unmount the user disk.
2. From the front of the device, unscrew the fastener on the left side of the SSD module, and then pull the SSD module from its slot.
3. Set aside the faulty SSD module.
4. Remove the new SSD module from the packaging.
5. Align the new SSD module with its open slot and then slide the unit in until it is seated in the connector.
6. Tighten the fastener to lock the SSD module in place.
7. With the device turned on, mount the user disk so that the device can access the SSD file system.
 - To mount the user disk, enter the `user-disk mount` command.
 - To verify the user disk is mounted, enter the `show user-disk` command.

Failure to mount the user disk prevents the device from automatically mounting the disk when you reboot the device.

External CFast storage card

The TPS 440T and 2200T devices come with a pre-formatted external CFast storage card.

Use the 8 GB external CFast card to store traffic logs, snapshots, and other system data.

Only CFast cards available from Trend Micro have been validated to achieve optimal performance with TippingPoint products. Other vendor cards are not supported. Using other vendor cards could be detrimental to proper operation of the TippingPoint system.

You can replace the CFast card when the system is operating.

**CAUTION!**

Before you remove the card, use the device CLI to first unmount the user disk. Failure to properly remove the TippingPoint CFast card can result in disk corruption and a system error. [Learn more on page 11-4](#) about using the external user disk commands.

After you insert a new card into the CFast slot, be sure to mount the user disk using the device CLI. Failure to mount the user disk prevents the device from automatically mounting the disk when you reboot the device.

External user disk commands

The following table provides information about the commands used to manage the external user disk (CFast or SSD) in the CLI.

Refer to the *TPS CLI Reference* for detailed documentation of these commands.

COMMAND	DESCRIPTION
<code>user-disk format</code>	Formats the external user disk. This command erases any existing data on the external user disk.
<code>user-disk mount</code>	Manually mounts the external user disk. If you replace the external user disk while the device is turned off, be sure to also restore power to the device so that you can mount the replacement disk. Failure to mount the replacement disk prevents the device from automatically mounting the disk when you reboot the device.
<code>user-disk unmount</code>	Unmounts the external user disk so that the user can remove it.

COMMAND	DESCRIPTION
user-disk encryption enable	Encrypts the external user disk if the system master key has been set. Changing the encryption status reformats the external user disk and erases all data on the drive.
user-disk encryption disable	Disables encryption of the external user disk if the system master key has been set. Changing the encryption status reformats the card and erases all data on the drive.
show user-disk	Shows properties of the external user disk, including operation status and capacity.
master-key set	Encrypts the external user disk and the system keystore by using the system master key. You are prompted to enter a master key that is between 9 and 32 characters in length, contains a combination of numbers and uppercase and lowercase letters, and that has at least one special character (for example, !@#).



TREND MICRO INCORPORATED

225 E. John Carpenter Freeway, Suite 1500
Irving, Texas 75062 U.S.A.
Phone: +1 (817) 569-8900, Toll-free: (888) 762-8736
Email: support@trendmicro.com

www.trendmicro.com

Item Code: TPEM09846/230927